

High –speed double diode

DAP202S3

Description

The DAP202S3 consists of two high-speed switching diodes with common anodes, fabricated in planar technology, and encapsulated in a small SOT-323 plastic SMD package.

Equivalent Circuit

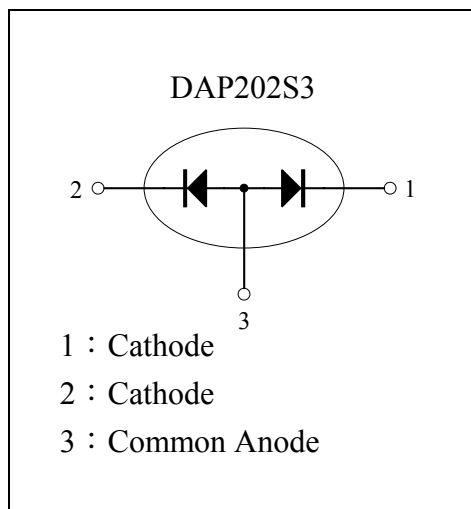

Outline

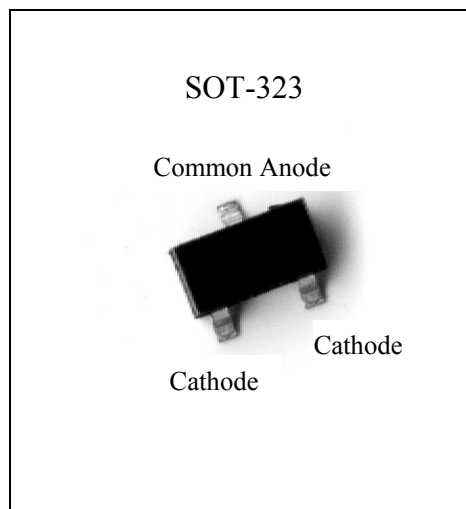

Features

- Small plastic SMD package
- High switching speed: max. 4ns
- Continuous reverse voltage: max. 75V
- Repetitive peak reverse voltage: max. 85V
- Repetitive peak forward current: max. 450mA.

Applications

- High-speed switching in thick and thin-film circuits.

**Absolute Maximum Ratings @ $T_A=25^{\circ}\text{C}$**

Parameters	Symbol	Min	Max	Unit
Repetitive peak reverse voltage	V_{RRM}	-	85	V
Continuous reverse voltage	V_R	-	75	V
Continuous forward current(single diode loaded)	I_F	-	215	mA
Continuous forward current(double diode loaded)		-	125	
Repetitive peak forward current	I_{FRM}		450	mA
Non-repetitive peak forward current @square wave, $T_j=125^{\circ}\text{C}$ prior to surge	I_{FSM}	$t=1\mu\text{s}$	4	A
		$t=1\text{ms}$	1	A
		$t=1\text{s}$	0.5	A
Total power dissipation(Note 1)	P_{tot}		200	mW
Junction Temperature	T_j	-	150	$^{\circ}\text{C}$
Storage Temperature	T_{stg}	-65	+150	$^{\circ}\text{C}$

Note 1: Device mounted on an FR-4 PCB.

Electrical Characteristics @ $T_j=25^{\circ}\text{C}$ unless otherwise specified

Parameters	Symbol	Conditions	Min	Typ.	Max	Unit
Forward voltage	V_F	$I_F=1\text{mA}$	-	-	715	mV
		$I_F=10\text{mA}$	-	-	855	mV
		$I_F=50\text{mA}$	-	-	1	V
		$I_F=150\text{mA}$	-	-	1.25	V
Reverse current	I_R	$V_R=25\text{V}$	-	-	30	nA
		$V_R=75\text{V}$	-	-	1	μA
		$V_R=25\text{V}, T_j=150^{\circ}\text{C}$	-	-	30	μA
		$V_R=75\text{V}, T_j=150^{\circ}\text{C}$	-	-	50	μA
Diode capacitance	C_d	$V_R=0\text{V}, f=1\text{MHz}$	-	-	2	pF
Reverse recovery time	t_{rr}	when switched from $I_F=10\text{mA}$ to $I_R=10\text{mA}, R_L=100\Omega$, measured at $I_R=1\text{mA}$	-	-	4	ns
Forward recovery voltage	V_{fr}	when switched from $I_F=10\text{mA}$ to $I_R=10\text{mA}$	-	-	1.75	V

Thermal Characteristics

Symbol	Parameter	Conditions	Value	Unit
$R_{th, j-a}$	thermal resistance from junction to ambient	Note 1	625	$^{\circ}\text{C}/\text{W}$

Note 1: Device mounted on a FR-4 PCB.

Characteristic Curves

Forward Current vs Ambient Temperature

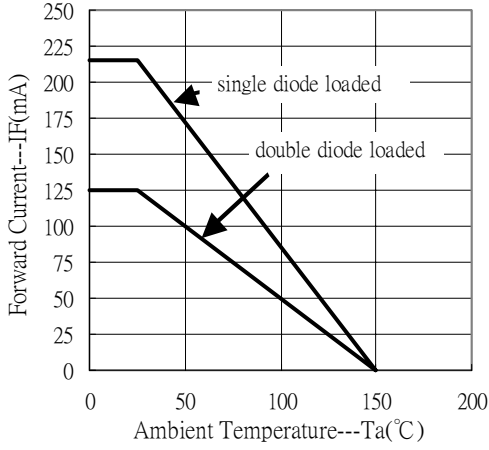

Forward Current vs Forward Voltage

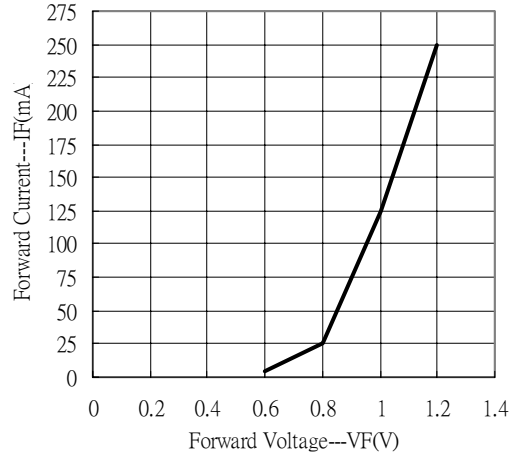

Non-repetitive peak forward current vs pulse duration

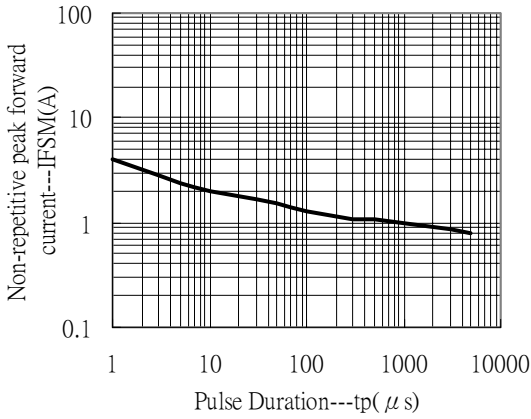

Diode Capacitance vs Reverse Voltage

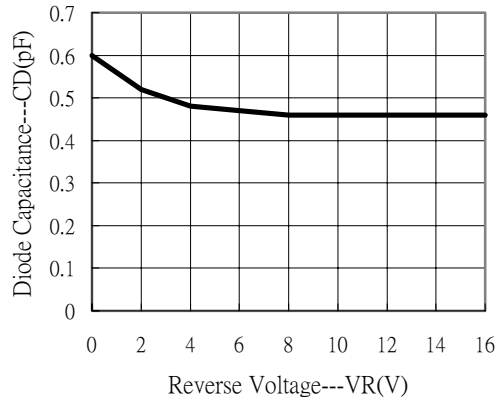

SOT-323 Dimension

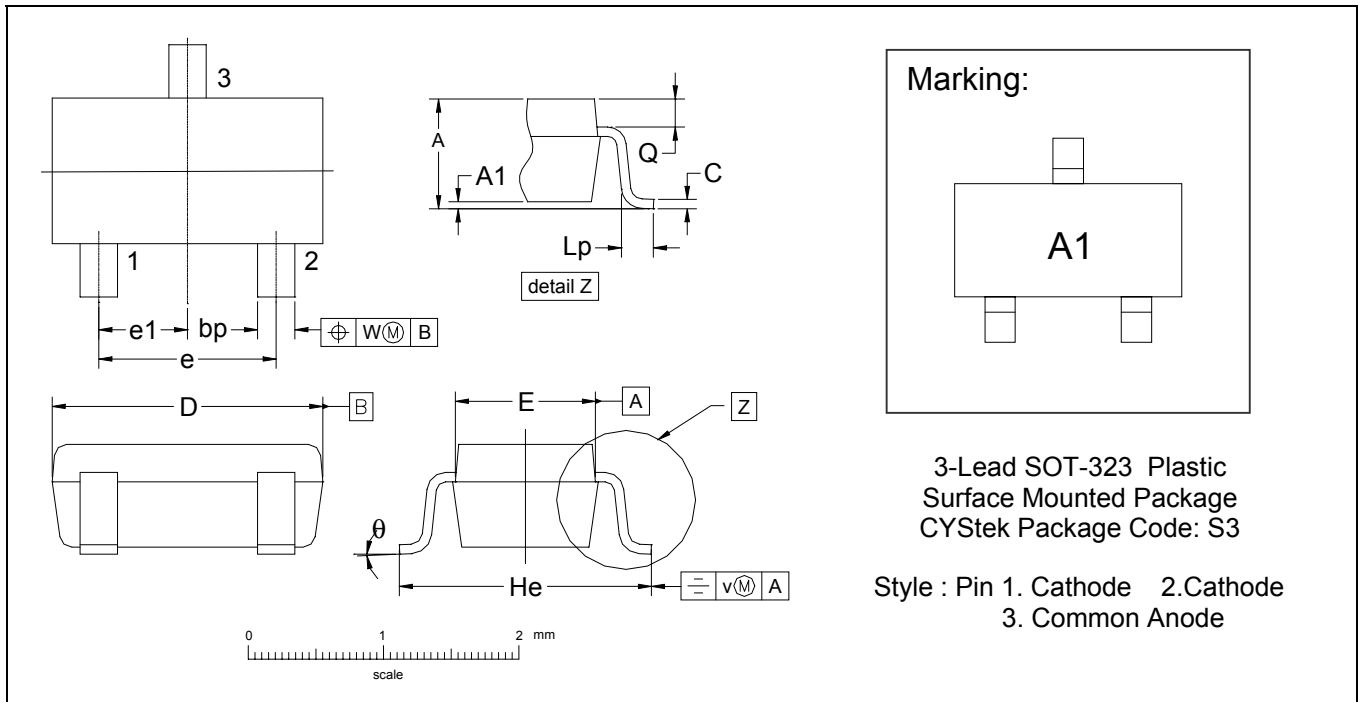

*: Typical

DIM	Inches		Millimeters		DIM	Inches		Millimeters	
	Min.	Max.	Min.	Max.		Min.	Max.	Min.	Max.
A	0.0315	0.0433	0.80	1.10	e1	0.0256	-	0.65	-
A1	0.0000	0.0039	0.00	0.10	He	0.0787	0.0886	2.00	2.25
bp	0.0118	0.0157	0.30	0.40	Lp	0.0059	0.0177	0.15	0.45
C	0.0039	0.0098	0.10	0.25	Q	0.0051	0.0091	0.13	0.23
D	0.0709	0.0866	1.80	2.20	v	0.0079	-	0.2	-
E	0.0453	0.0531	1.15	1.35	w	0.0079	-	0.2	-
e	0.0512	-	1.3	-	θ	-	-	10°	0°

Notes: 1.Controlling dimension: millimeters.
 2.Maximum lead thickness includes lead finish thickness, and minimum lead thickness is the minimum thickness of base material.
 3.If there is any question with packing specification or packing method, please contact your local CYStek sales office.

Material:

- Lead: 42 Alloy ; solder plating
- Mold Compound: Epoxy resin family, flammability solid burning class: UL94V-0

Important Notice:

- All rights are reserved. Reproduction in whole or in part is prohibited without the prior written approval of CYStek.
- CYStek reserves the right to make changes to its products without notice.
- CYStek **semiconductor products are not warranted to be suitable for use in Life-Support Applications, or systems.**
- CYStek assumes no liability for any consequence of customer product design, infringement of patents, or application assistance.